

Initial R Words

Instructions _____

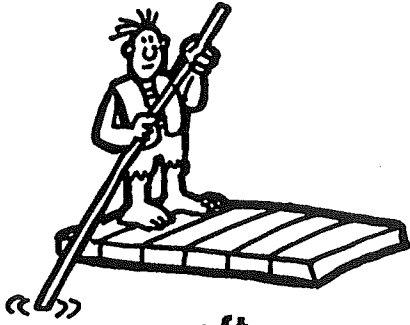

raft



ram



rain



rash



rat



read

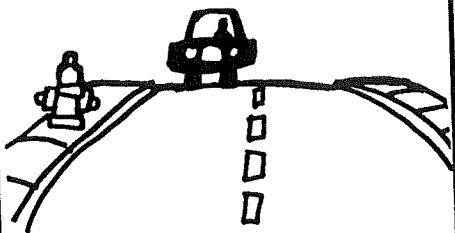

road



robe

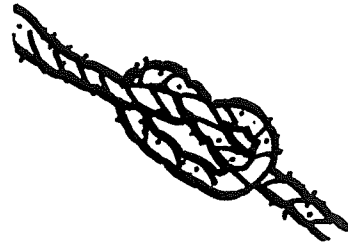

rope

© 1993, Super Duper School Co.

Name _____

Date _____



Helper's Signature _____



Skill: Initial R in words

Speech-Language Pathologist

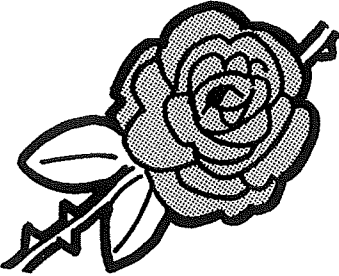
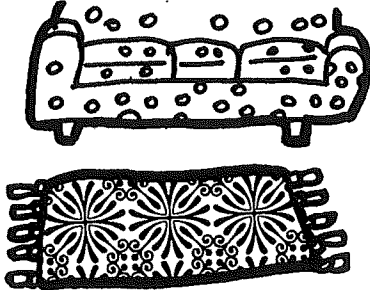
Initial R Words

Instructions _____

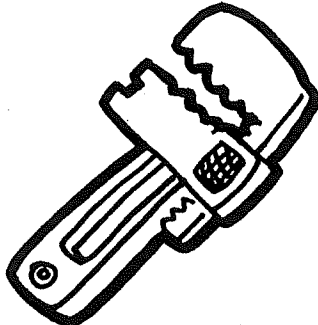
 <p>rose</p>	 <p>rug</p>	 <p>ring</p>
---	---	---

 <p>wreath</p>	 <p>wrench</p>	 <p>roof</p>
--	---	--

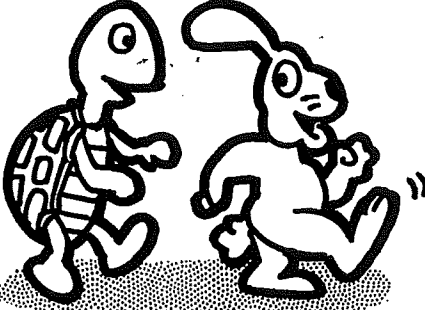
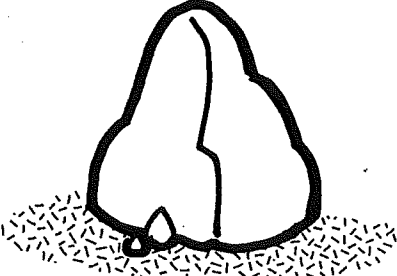
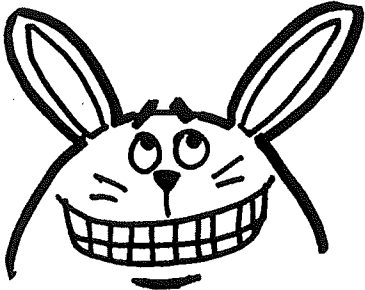
 <p>race</p>	 <p>rock</p>	 <p>rabbit</p>
---	--	---

Name _____

Date _____

Helper's Signature _____

Skill: Initial R in words

Speech-Language Pathologist

Initial R Words

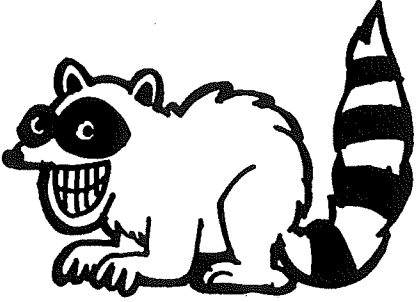
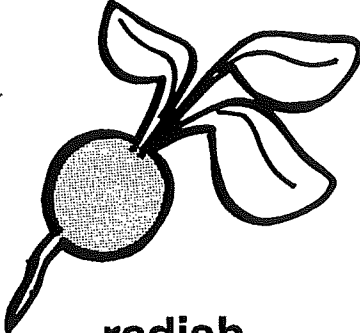
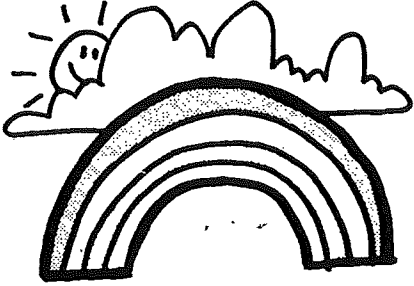

Instructions _____

 <p>raccoon</p>	 <p>radish</p>	 <p>rainbow</p>
---	---	---

--	--	--	--	--	--	--	--	--	--	--	--

--	--	--	--	--	--	--	--	--	--	--	--

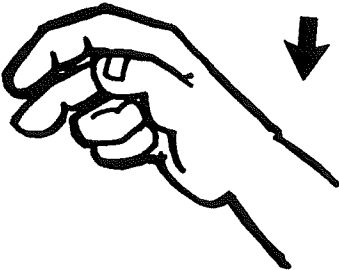
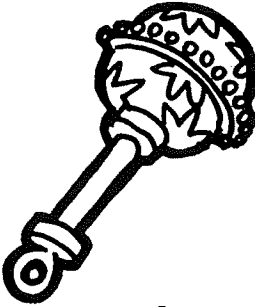
--	--	--	--	--	--	--	--	--	--	--	--

 <p>wrist</p>	 <p>rattle</p>	 <p>raincoat</p>
---	--	--

--	--	--	--	--	--	--	--	--	--	--	--

--	--	--	--	--	--	--	--	--	--	--	--

--	--	--	--	--	--	--	--	--	--	--	--

 <p>robin</p>	 <p>ribbon</p>	 <p>robot</p>
---	---	--

--	--	--	--	--	--	--	--	--	--	--	--

--	--	--	--	--	--	--	--	--	--	--	--

--	--	--	--	--	--	--	--	--	--	--	--

© 1993, Super Dupere School Co.

Name _____

Date _____

Helper's Signature _____

Skill: Initial R in words

Speech-Language Pathologist

Initial R Words

Instructions _____

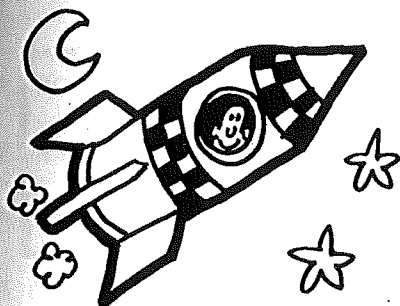

rocket

--	--	--	--	--	--	--	--	--	--	--	--

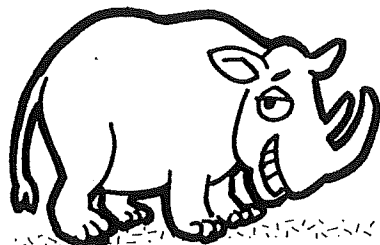

rhino

--	--	--	--	--	--	--	--	--	--	--	--



radio

--	--	--	--	--	--	--	--	--	--	--	--

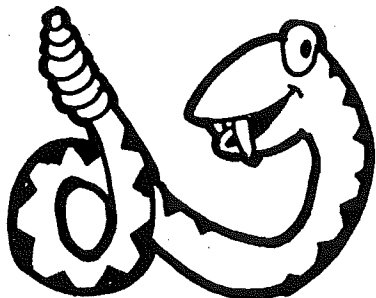

rattlesnake

--	--	--	--	--	--	--	--	--	--	--	--



relatives

--	--	--	--	--	--	--	--	--	--	--	--



rake

--	--	--	--	--	--	--	--	--	--	--	--

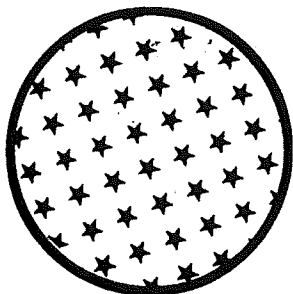

round

--	--	--	--	--	--	--	--	--	--	--	--

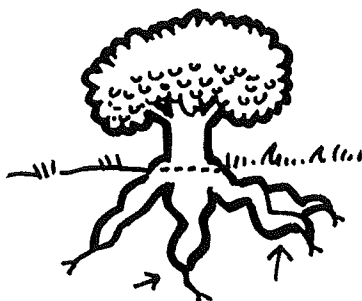

roots

--	--	--	--	--	--	--	--	--	--	--	--



ruffles

--	--	--	--	--	--	--	--	--	--	--	--

Name _____

Date _____

Helper's Signature _____



Skill: Initial R in words

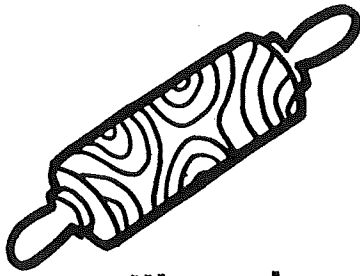
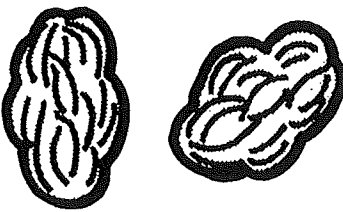
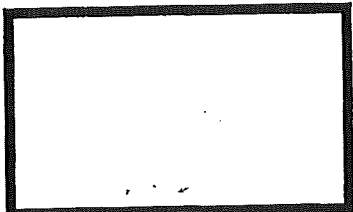

Speech-Language Pathologist _____

Initial R Words

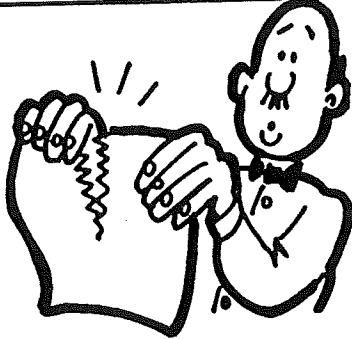
Instructions _____

 <p>rolling pin</p>	 <p>raisins</p>	 <p>rectangle</p>
--	--	--

 <p>rip</p>	 <p>reach</p>	 <p>rules</p>
---	---	---

 <p>roll</p>	 <p>resting</p>	 <p>rhumba</p>
---	--	---

Name _____

Date _____



Helper's Signature _____

Skill: Initial R in words

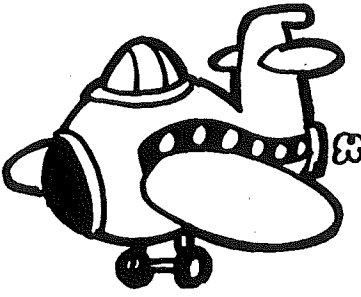
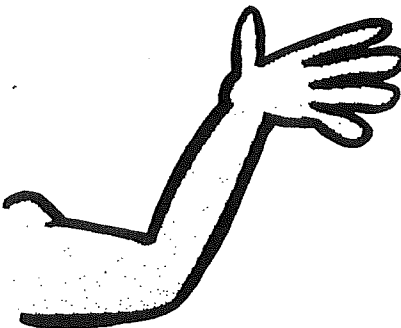

Speech-Language Pathologist

Medial R Words

Instructions _____

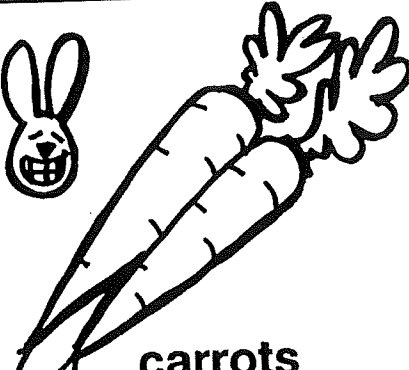
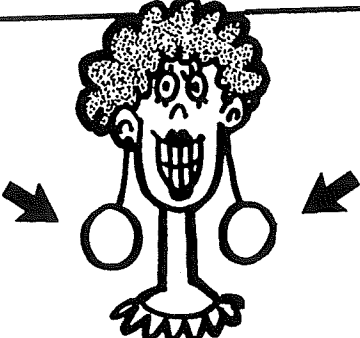
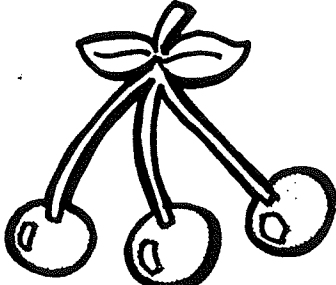
 <p>airplane</p>	 <p>arm</p>	 <p>bird</p>
---	--	---

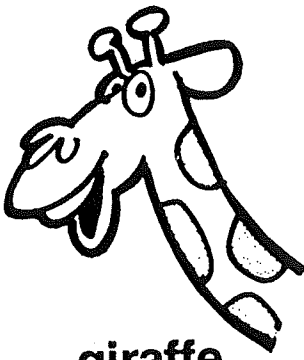
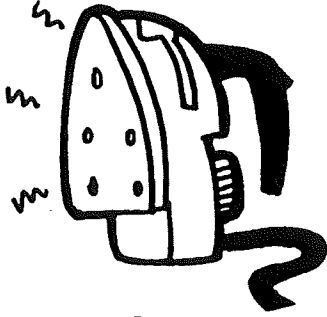
 <p>carrots</p>	 <p>earrings</p>	 <p>cherries</p>
---	--	--

 <p>giraffe</p>	 <p>iron</p>	 <p>horse</p>
--	---	--

Name _____

Date _____



Helper's Signature _____

Skill: Medial R in words

Speech-Language Pathologist

Medial R Words

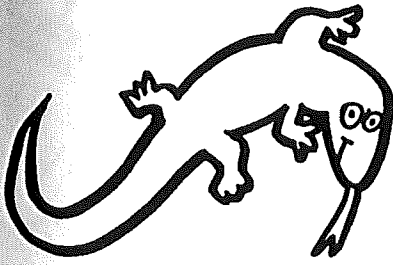
Instructions _____

 <p>lizard</p>	 <p>marbles</p>	 <p>fairy</p>
---	---	--

--	--	--	--	--	--	--	--	--	--	--	--

--	--	--	--	--	--	--	--	--	--	--	--

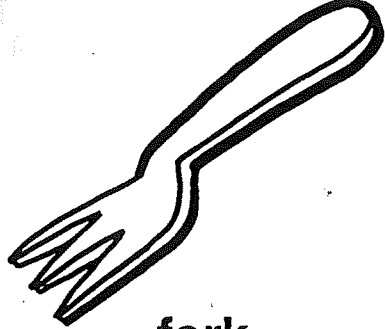
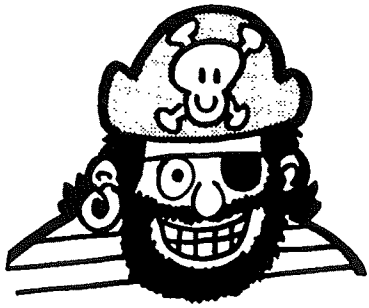
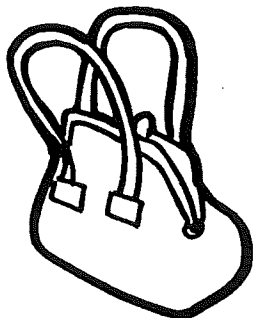

--	--	--	--	--	--	--	--	--	--	--	--

 <p>fork</p>	 <p>pirate</p>	 <p>purse</p>
--	---	---

--	--	--	--	--	--	--	--	--	--	--	--

--	--	--	--	--	--	--	--	--	--	--	--

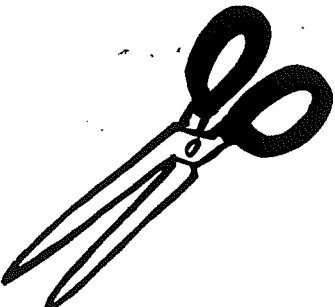
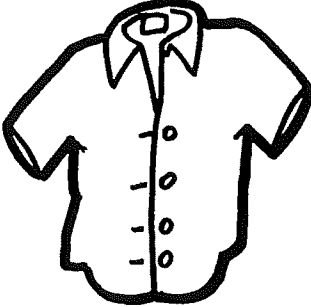
--	--	--	--	--	--	--	--	--	--	--	--

 <p>scissors</p>	 <p>shirt</p>	 <p>sheriff</p>
---	--	--

--	--	--	--	--	--	--	--	--	--	--	--

--	--	--	--	--	--	--	--	--	--	--	--

--	--	--	--	--	--	--	--	--	--	--	--

Name _____

Date _____

Helper's Signature _____

Skill: Medial R in words

Speech-Language Pathologist

Medial R Words

Instructions _____



squirrel

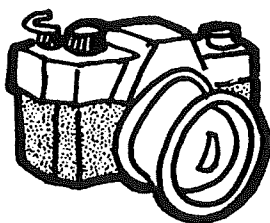

camera



parachute

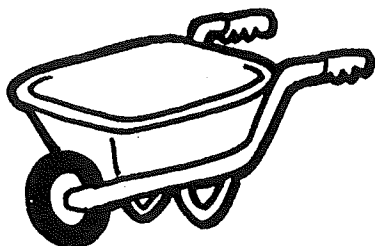

wheelbarrow

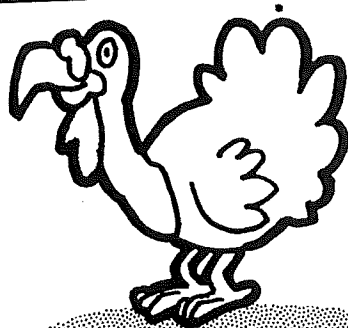

turkey

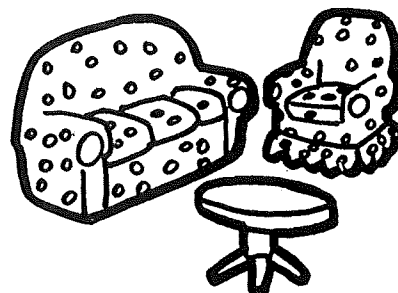

furniture

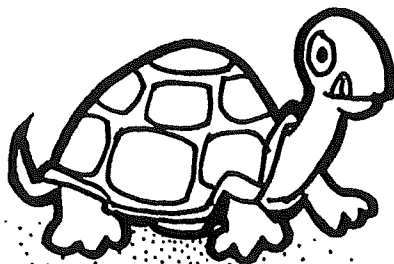

turtle

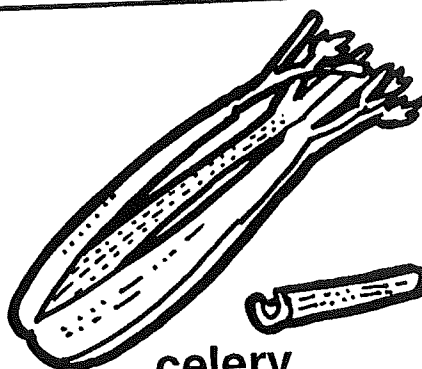

celery

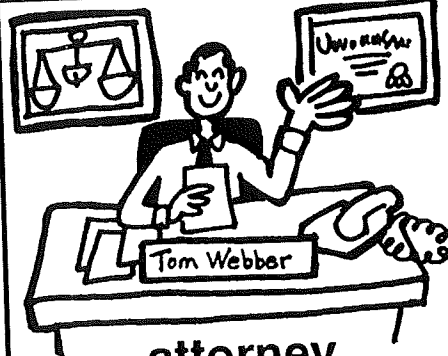

attorney

Name _____

Date _____

Helper's Signature _____

Skill: Medial R in words

Speech-Language Pathologist

Medial R Words

Instructions _____

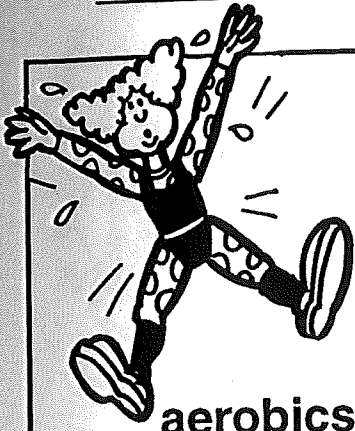

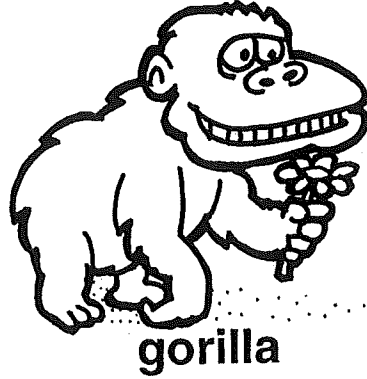

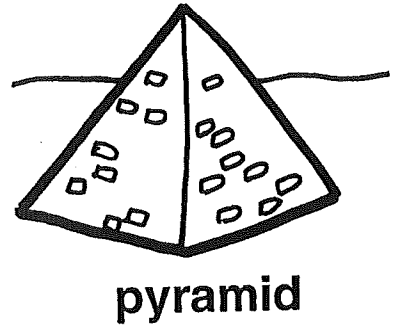

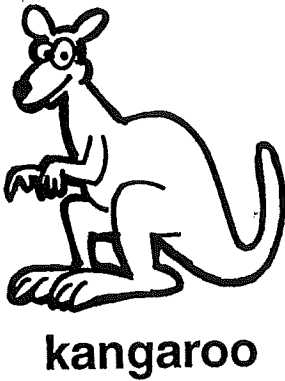

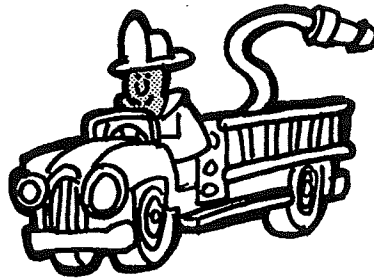

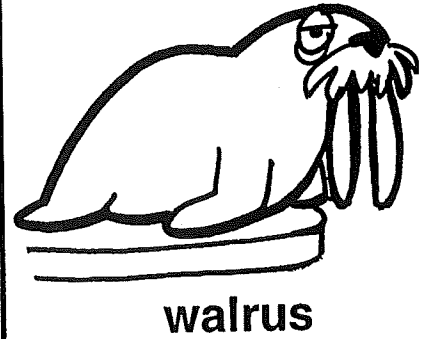



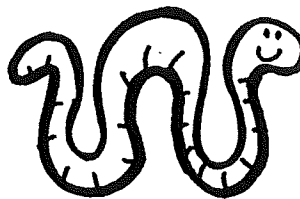



© 1993, Super Dupere School Co.

Name _____

Date _____



Helper's Signature _____



Skill: Medial R in words



Speech-Language Pathologist _____

Medial R Words

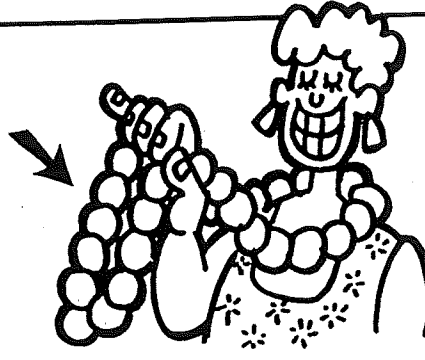
Instructions _____

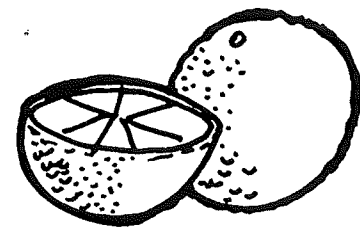
 <p>clarinet</p>	 <p>parasol</p>	 <p>tourist</p>
---	--	--

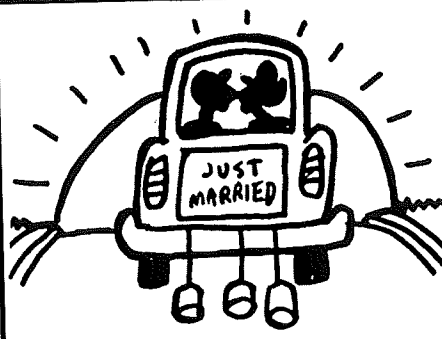
 <p>pearls</p>	 <p>park</p>	 <p>orange</p>
--	--	--

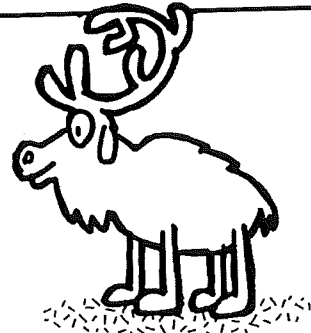
 <p>married</p>	 <p>syrup</p>	 <p>caribou</p>
--	--	--

© 1993, Super Dupers School Co.

Name _____

Date _____

Helper's Signature _____

Skill: Medial R in words

Speech-Language Pathologist

Medial R Words

Instructions _____

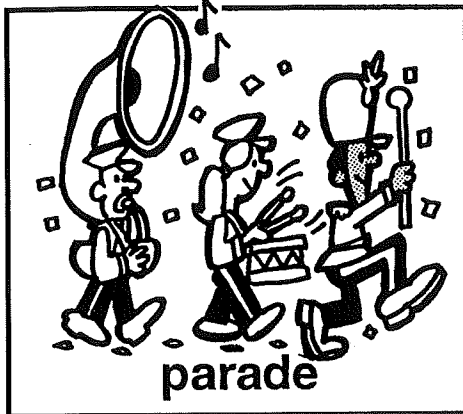

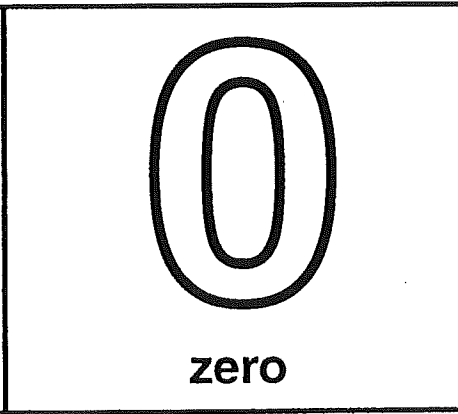



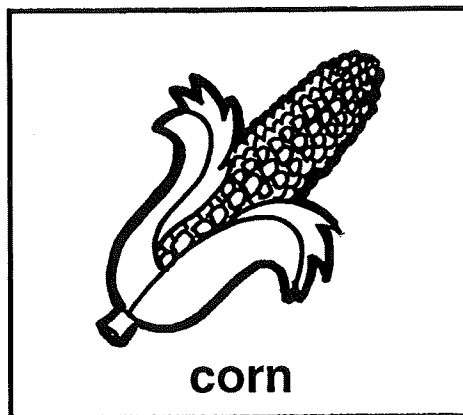

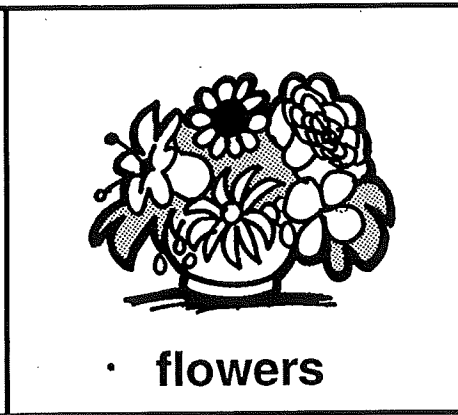



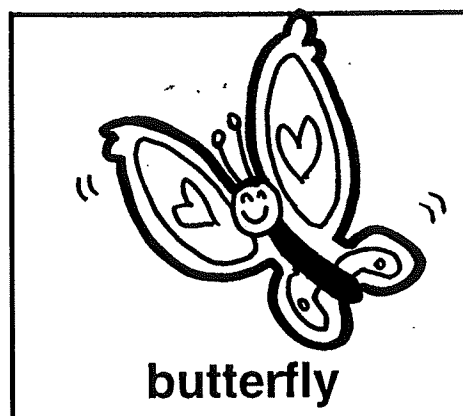

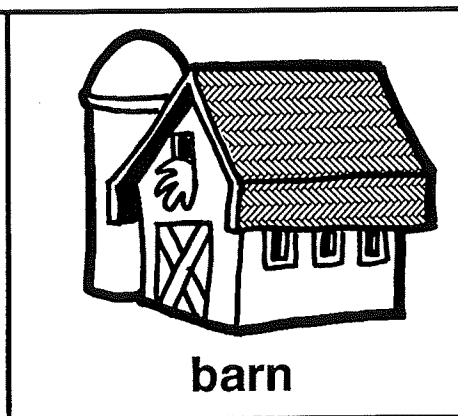

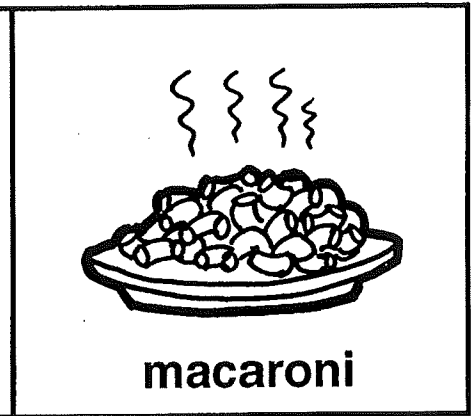

© 1993, Super Dupere School Co.

Name _____

Date _____

Helper's Signature _____



Skill: Medial R in words

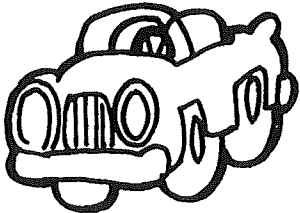
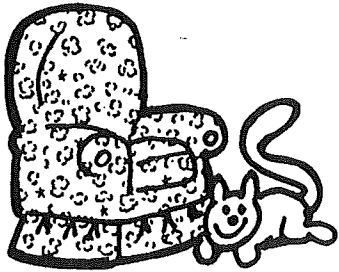

Speech-Language Pathologist _____

Final R Words

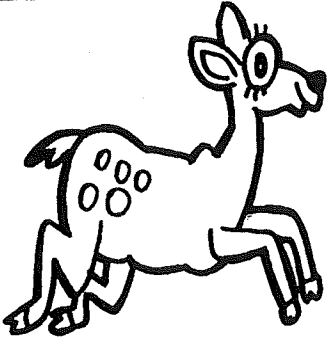
Instructions _____

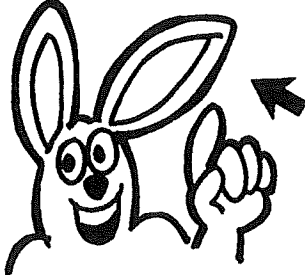
 <p>bear</p>	 <p>car</p>	 <p>chair</p>
---	---	--

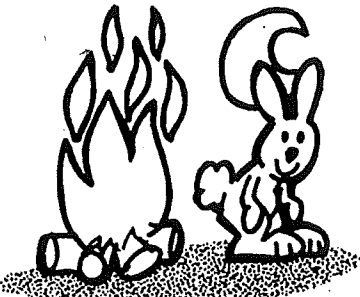
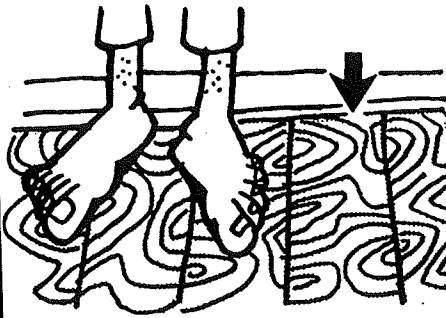
 <p>deer</p>	 <p>door</p>	 <p>ear</p>
--	---	---

 <p>fire</p>	 <p>floor</p>	 <p>four</p>
---	---	---

Name _____

Date _____

Helper's Signature _____

Skill: Final R in words

Speech-Language Pathologist _____

Final R Words

Instructions _____



hair

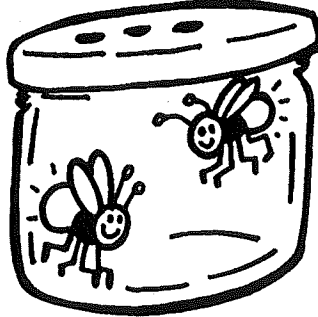

jar

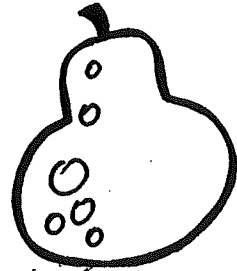

pear

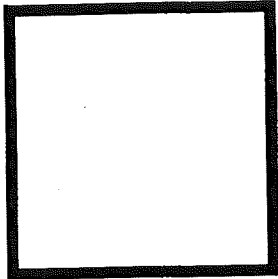

square

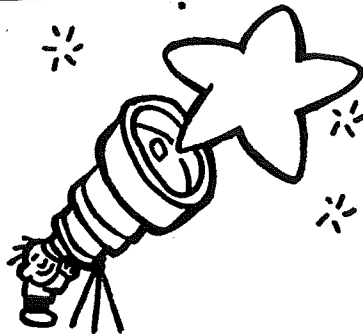

star

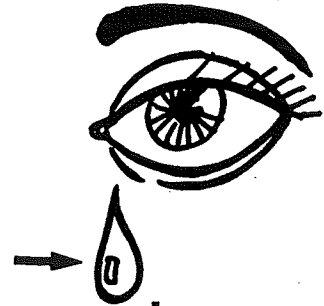

tear

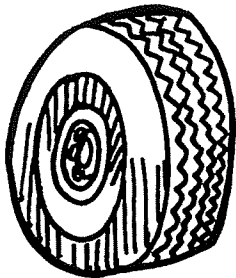

tire

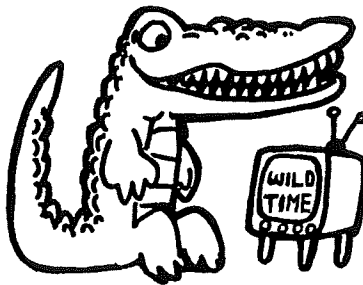

alligator

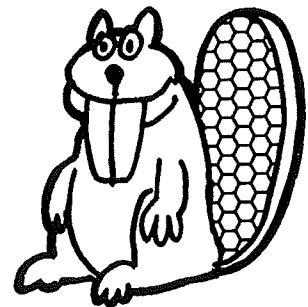

beaver

Name _____

Date _____

Helper's Signature _____

Skill: Final R in words

Final R Words

Instructions _____

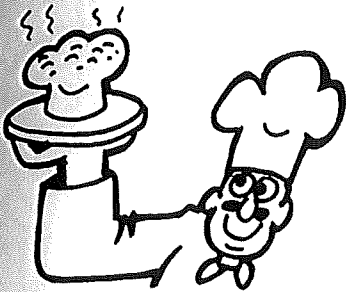

baker

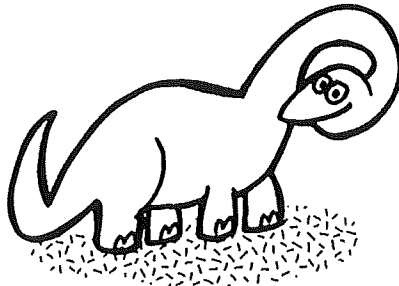

dinosaur

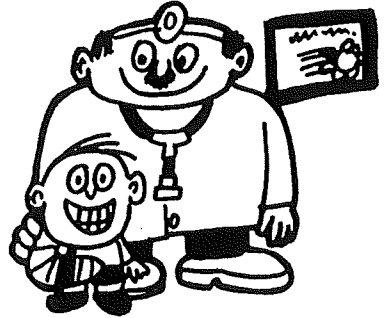

doctor

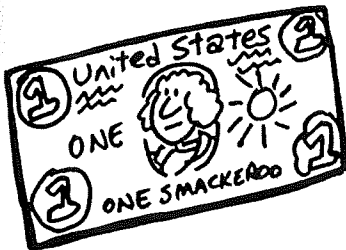

dollar

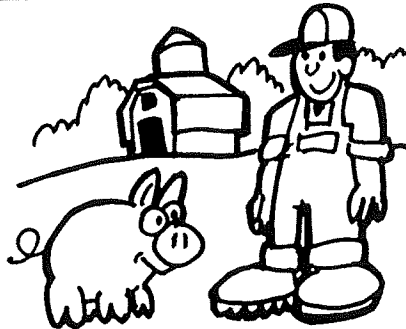

farmer

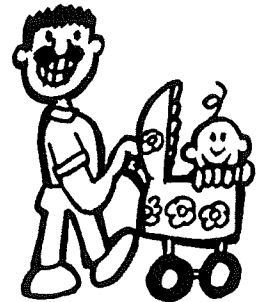

father

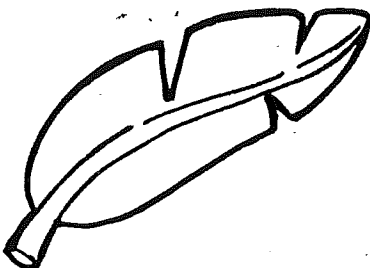

feather

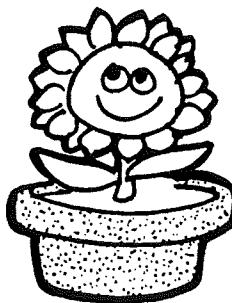

flower



gopher

Name _____

Date _____

Helper's Signature _____



Skill: Final R in words

Speech-Language Pathologist _____

Final R Words

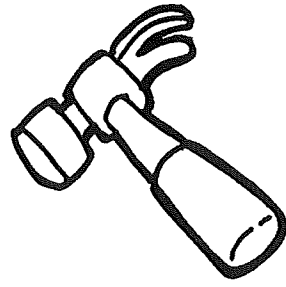
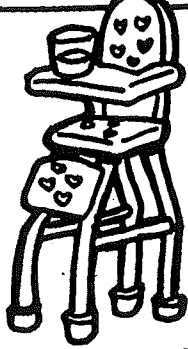
Instructions _____

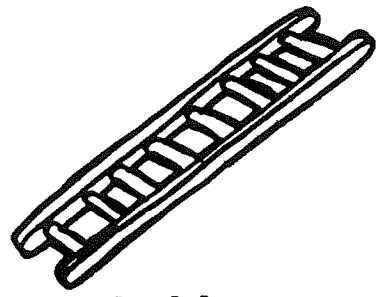
 <p>guitar</p>	 <p>hammer</p>	 <p>highchair</p>
--	--	---

 <p>juggler</p>	 <p>ladder</p>	 <p>letter</p>
--	---	---

 <p>lobster</p>	 <p>matador</p>	 <p>mother</p>
---	--	--

Name _____ Date _____

Helper's Signature _____
Skill: Final R in words

Final R Words

Instructions _____



newspaper

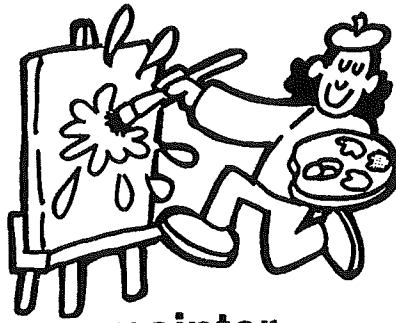

painter



panther



sailor

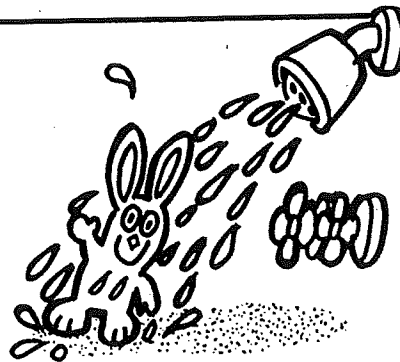

shower

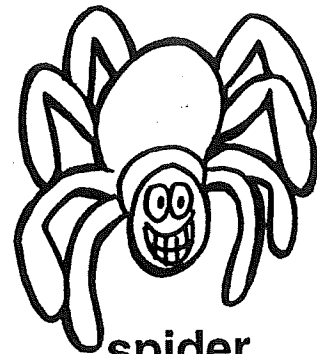

spider



sugar

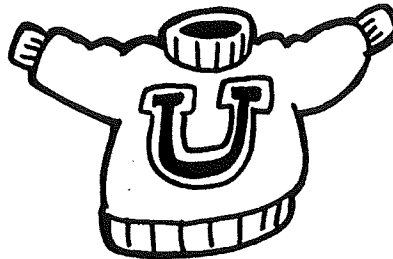

sweater



teacher

Name _____

Date _____

Helper's Signature _____

Skill: Final R in words

Speech-Language Pathologist _____

Final R Words

Instructions _____



tiger

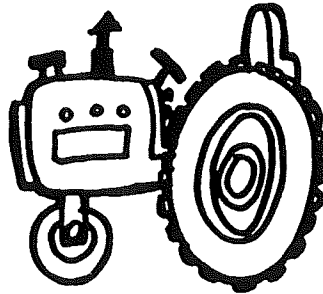

tractor



umpire



vampire

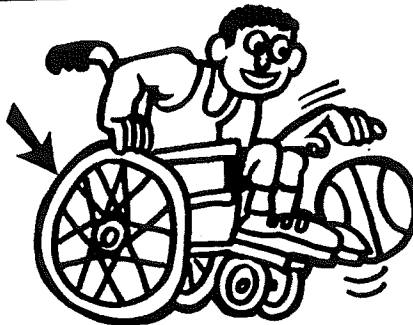

wheelchair

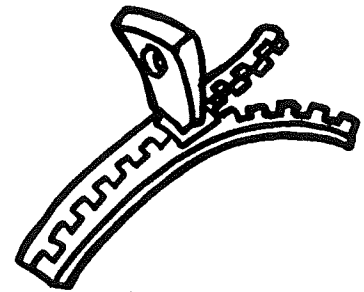

zipper



plumber

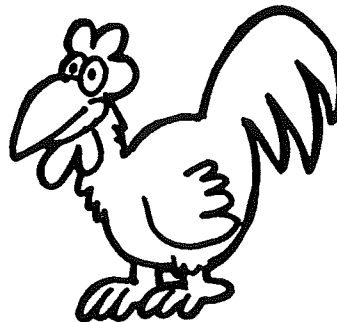

rooster

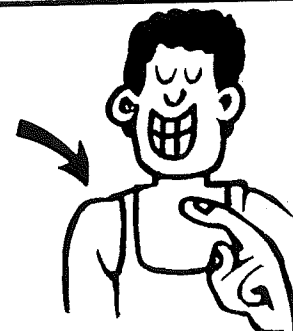

shoulder

Name _____

Date _____

Helper's Signature _____

Skill: Final R in words